

DATE	RODALE CROP ROLLER		NO.	DATE	REVISIONS
	NOTES:				
DRAWN BY					
JOB NO.					
SCALE					
SHEET					
OF SHEETS					

COMPANY
 ADDRESS
 CITY, STATE, ZIP
 BERKS TECHNICAL INSTITUTE
 DRAFTING DEPARTMENT
 2205 RIDGEWOOD ROAD
 MYNERSBURG, PA 17810
 PHONE NO. (800)-821-4662

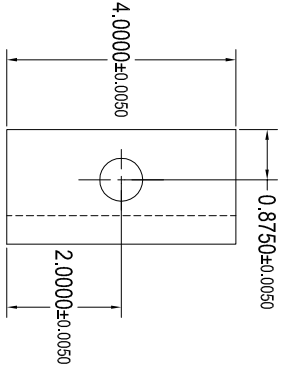

PART #3

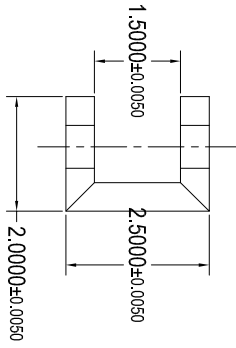
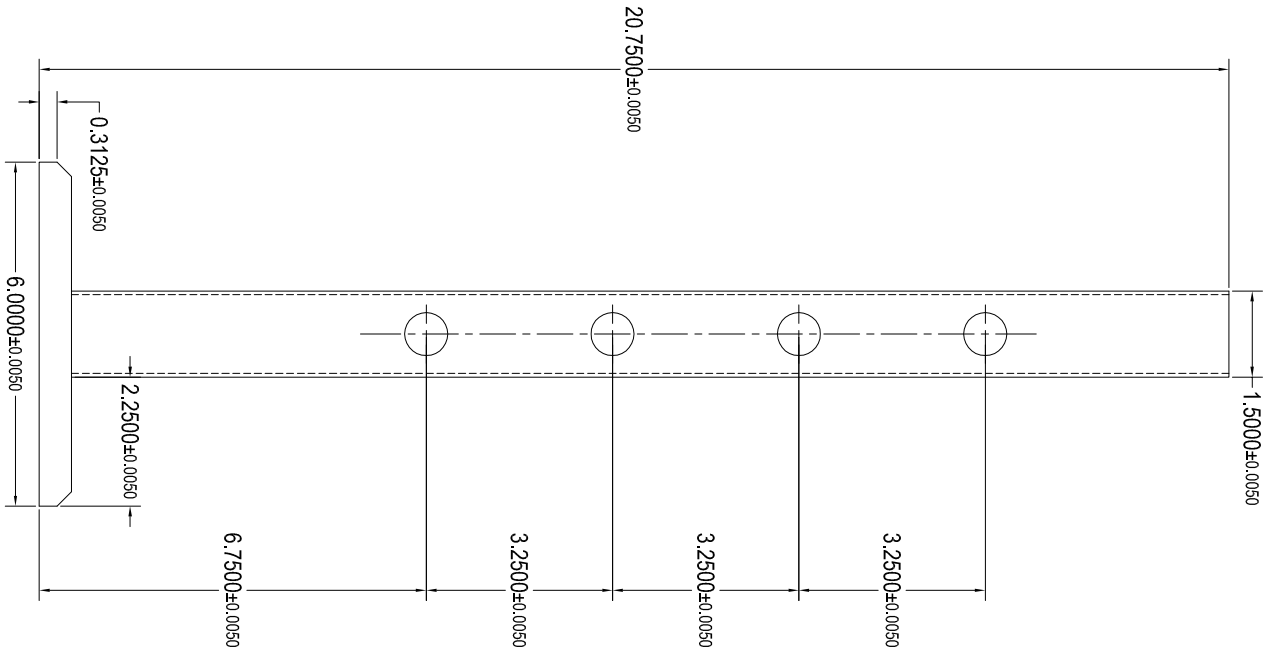

PART #2

NO.	DATE	REVISIONS

COMPANY
ADDRESS
CITY, STATE, ZIP
BERKS TECHNICAL INSTITUTE
DRAFTING DEPARTMENT
2205 RIDGEWOOD ROAD
WYOMISSING, PA 19110
PHONE NO. (800)-821-4662

RODALE CROP ROLLER

NOTES:

DATE: _____
DRAWN BY: _____
JOB NO: _____
SCALE: _____
SHEET _____
OF _____ SHEETS

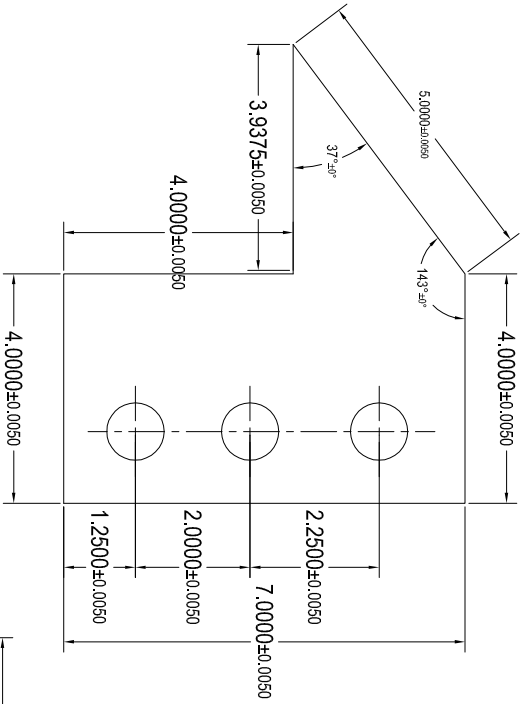

PART #5

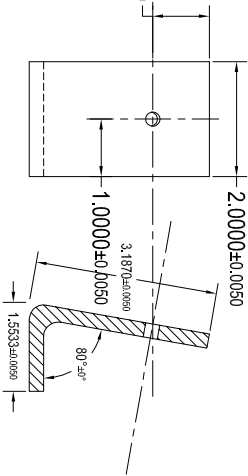

PART #R7

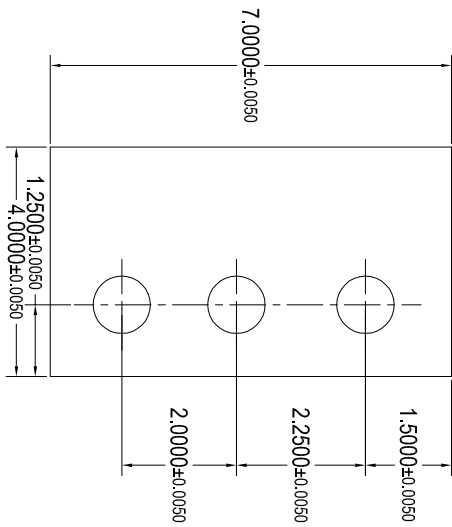

PART #4

NO.	DATE	REVISIONS

COMPANY
 ADDRESS
 CITY, STATE, ZIP
 BERKS TECHNICAL INSTITUTE
 DRAFTING DEPARTMENT
 2205 RIDGEWOOD ROAD
 MYNERSBURG, PA 19810
 PHONE NO. (800)-821-4662

RODALE CROP ROLLER

NOTES:

DATE:	
DRAWN BY:	
JOB NO.:	
SCALE:	
SHEET:	
SHEETS:	

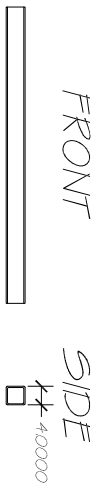

ANGLED
BRACES

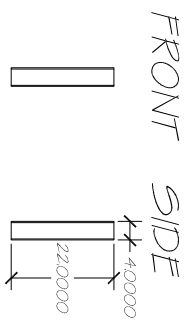
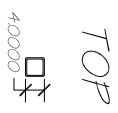

MIDDLE
POST

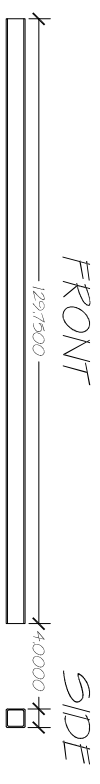

BOTTOM
TUBE

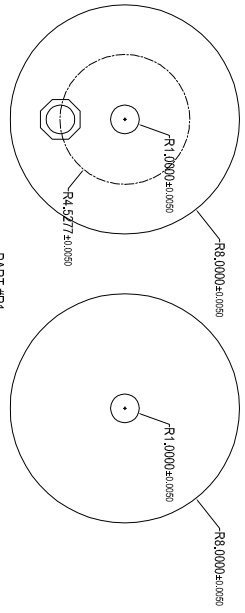

PART #R1

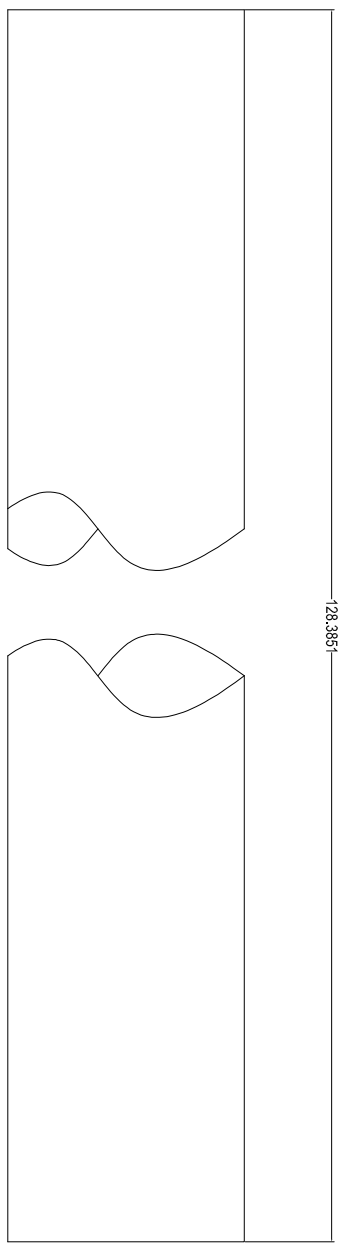

PART #R1

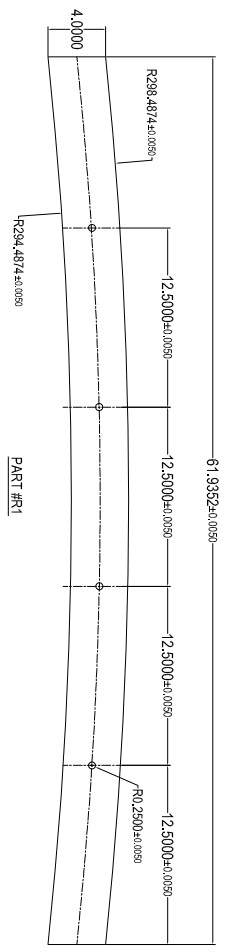

PART #R1

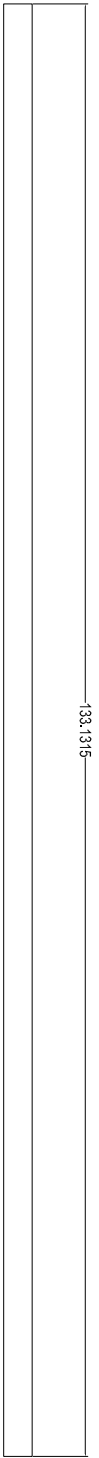

PART #R1

NO.	DATE	REVISIONS

COMPANY
 ADDRESS
 CITY, STATE, ZIP
 BERKS TECHNICAL INSTITUTE
 DRAFTING DEPARTMENT
 2205 RIDGEWOOD ROAD
 MYNERSBURG, PA 19610
 PHONE NO. (800) 821-4662

RODALE CROP ROLLER
 NOTES:

DATE: _____
 DRAWN BY: _____
 JOB NO: _____
 SCALE: _____
 SHEET _____
 OF _____ SHEETS

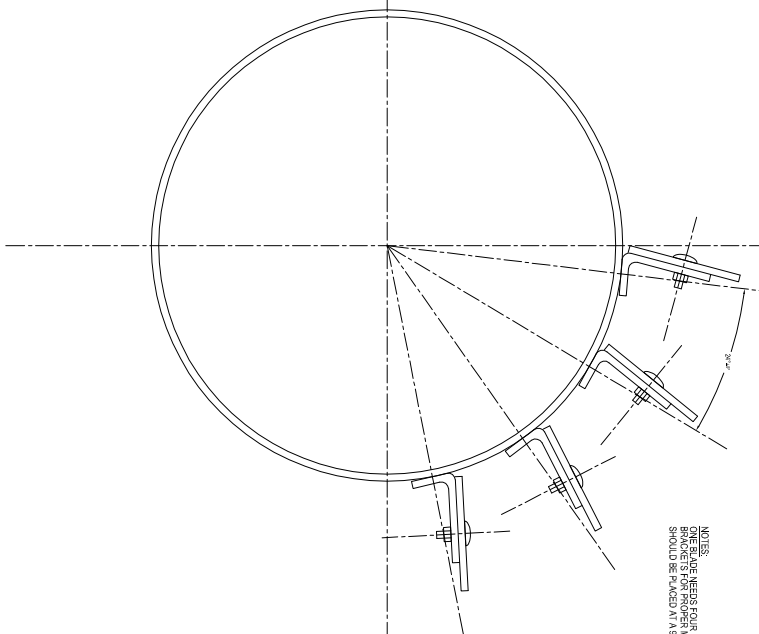
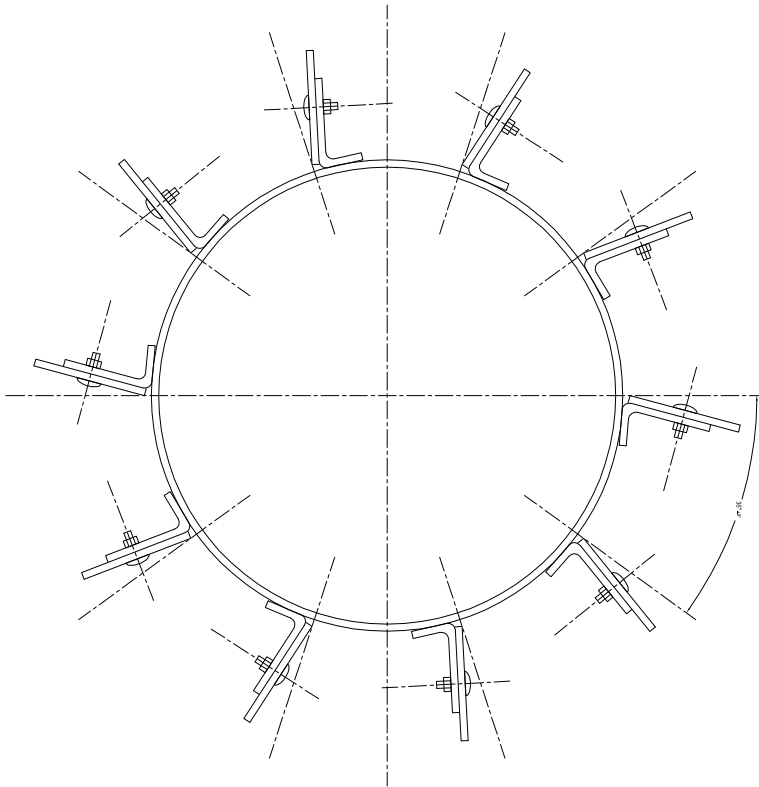

NOTES:
 ONE END, WE NEEDS FOUR EQUALLY SPACED ANGLE
 BRACKETS FOR PROPER MOUNTING. ALL ANGLES
 SHOULD BE FOLDED IN A 45 ANGLE.

DATE: _____
 DRAWN BY: _____
 DES. NO.: _____
 SCALE: _____
 SHEET _____

RODALE CROP ROLLER

NOTES:

COMPANY
 ADDRESS
 CITY, STATE, ZIP
 BERKS TECHNICAL INSTITUTE
 DRAFTING DEPARTMENT
 2205 RIDGEWOOD ROAD
 WYOMISSING, PA 19610
 PHONE NO. (800)-621-4662

NO.	DATE	REVISIONS

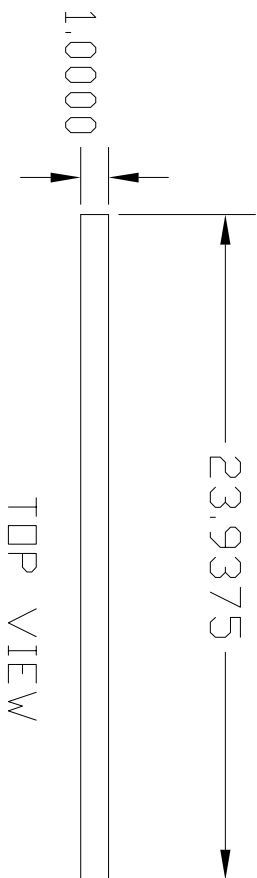

TOP VIEW

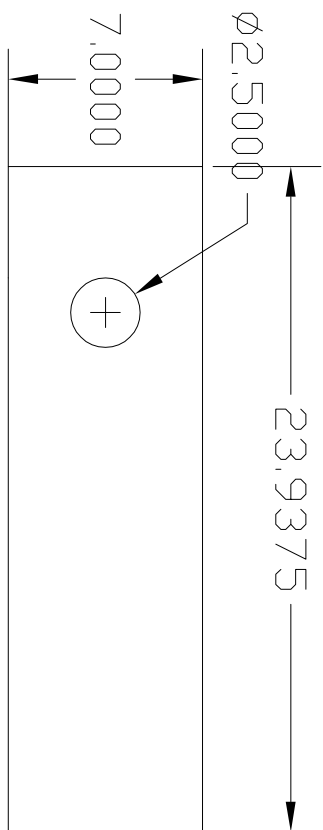

SIDE VIEW

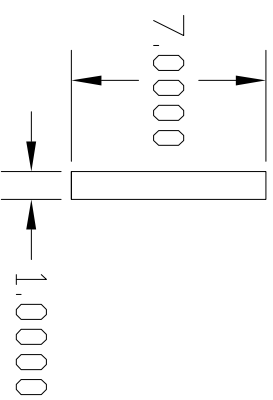

FRONT VIEW

SIDE ARM

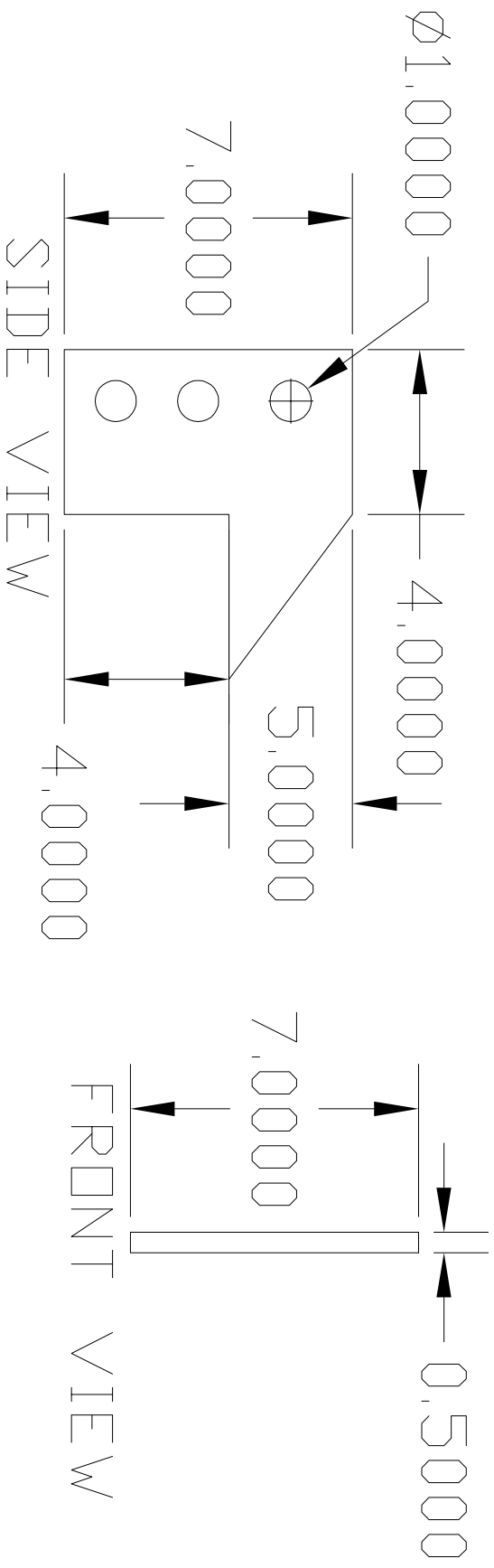
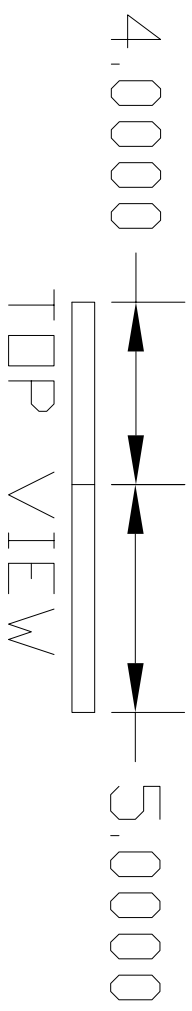

THREE HOLE STEEL PLATE WITH ANGLE PART

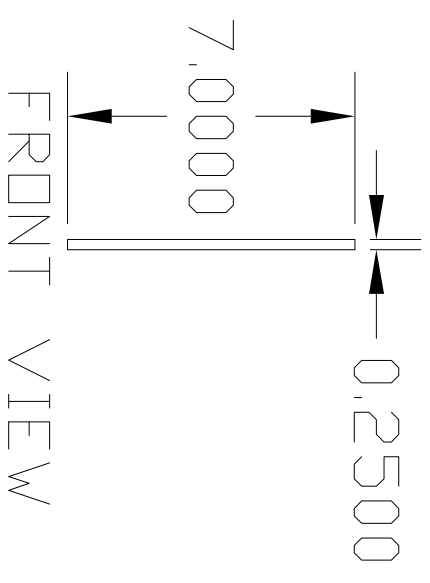
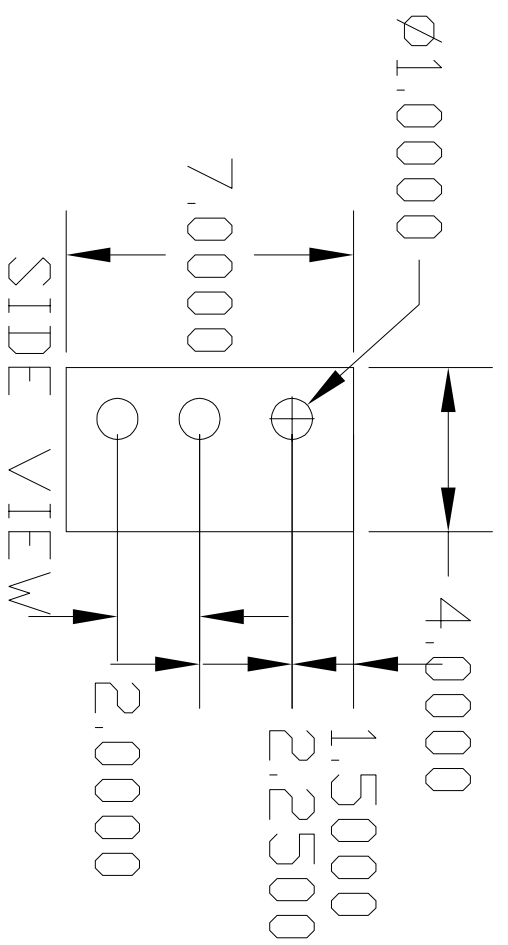
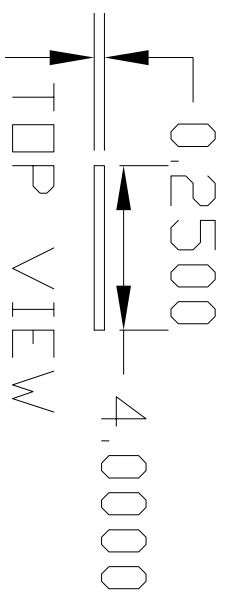

THREE HOLE STEEL PLATE WITH OUT ANGLE PART

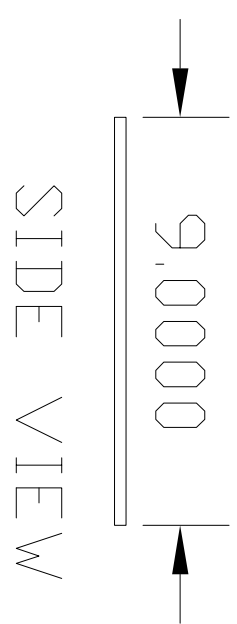
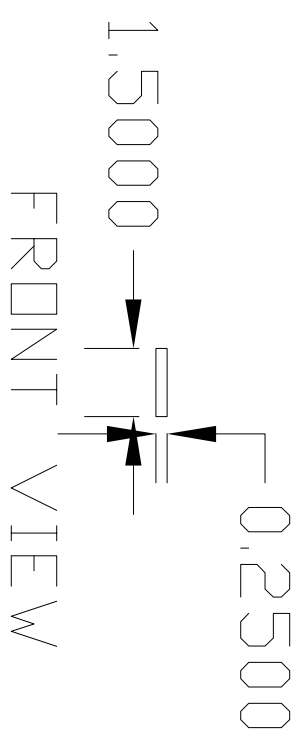
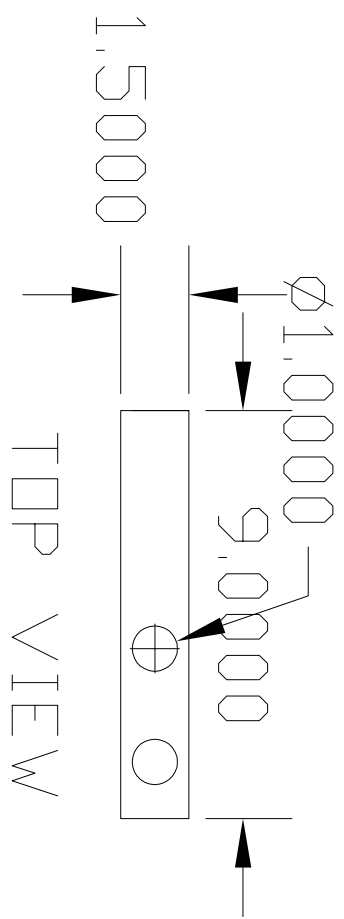

PLATES FOR TOP AND BOTTOM OF ARM

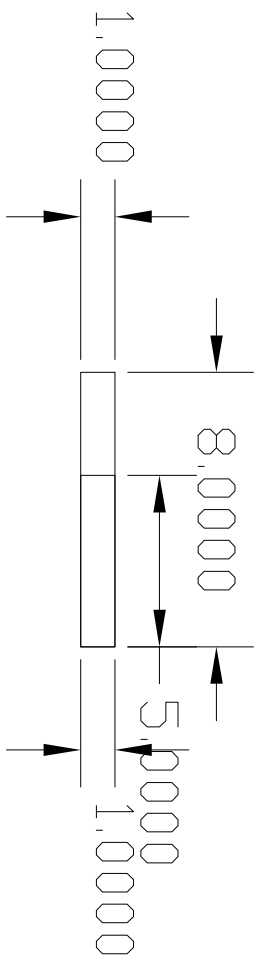

TOP VIEW

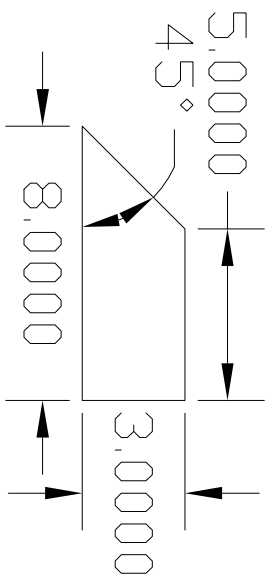

SIDE VIEW

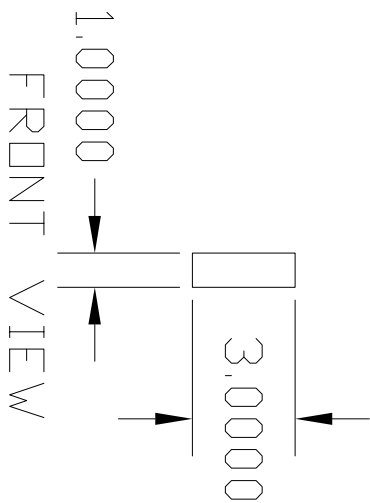

FRONT VIEW

ANGLE BRACE HOLDER

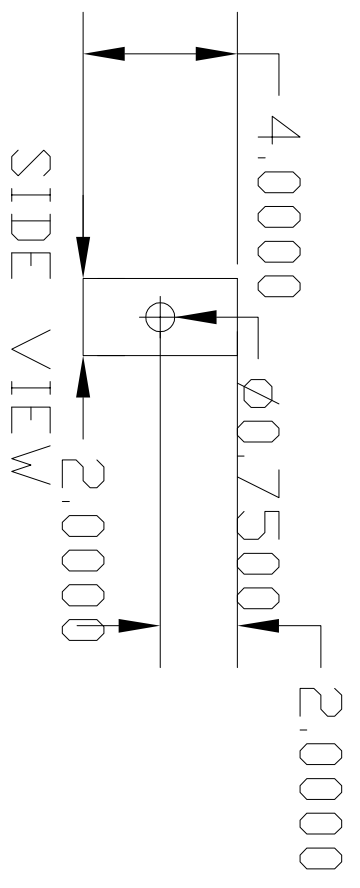
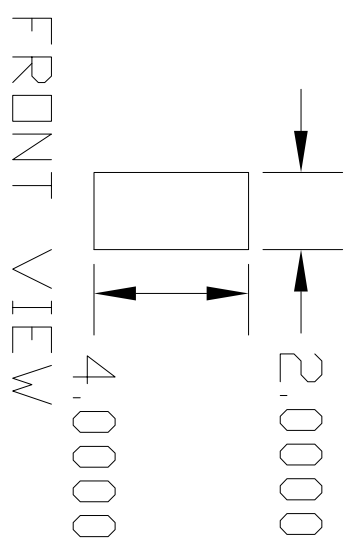
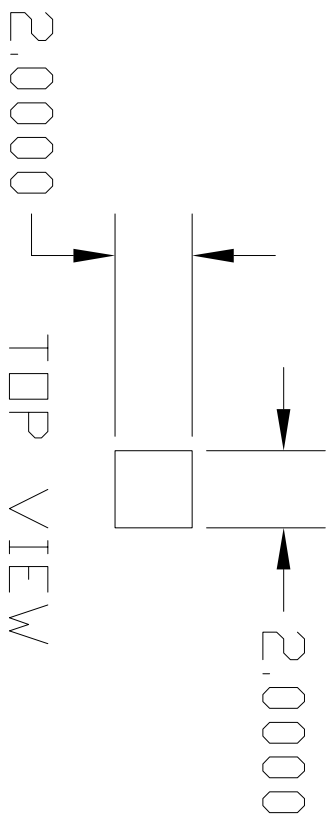

HOLDER FOR THE ROLLER HOLDER

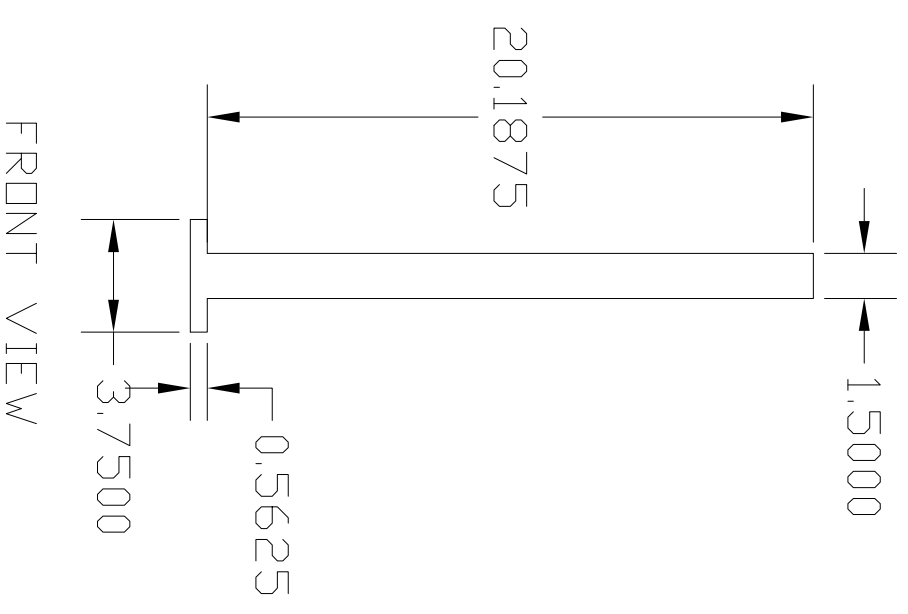
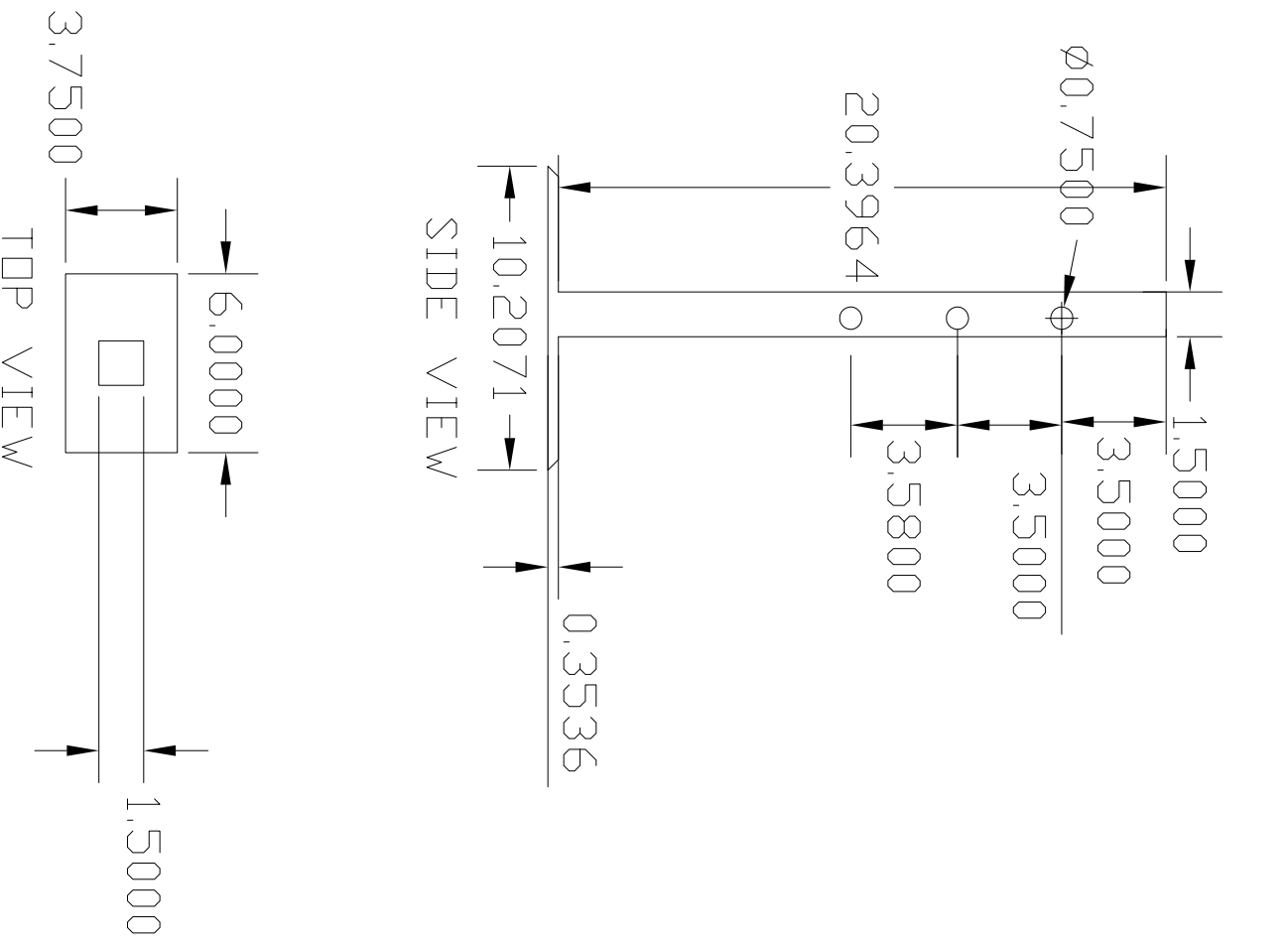

ROLLER HOLDER